



Heckmann Building Products Inc.

1501 N. 31st Avenue

Melrose Park, IL 60160-2911

800-621-4140 or 708-865-2403 Fax: 708-865-2640

www.heckmannbuildingprods.com

SUBMITTAL SHEET: NO. 370 SEISMIC HOOK TAB

Standard Sizes:

22Ga clip 7/8" wide 9/16" long with a 1/4" o.d. bend available in Hotdip and Stainless Steel.

The #370 Seismic Hook Tab is factory welded to any of our 3/16" Wire veneer anchors for exterior veneer seismic requirements for seismic zones E and F.

Specification of the Seismic Hook Tab:

You would first specify the wire veneer anchor and then add in the seismic clip specifications. Two examples follow:

Pos-I-Tie® Brick Veneer Seismic Triangle Tie:
3/16" diameter x [Length] with Welded #370 Seismic Hook tab in [Hotdip Galvanized][Stainless Steel].

#316 Seismic Triangle Tie: 3/16" diameter x [Length] with Welded #370 Seismic Hook tab in [Hotdip Galvanized][Stainless Steel].

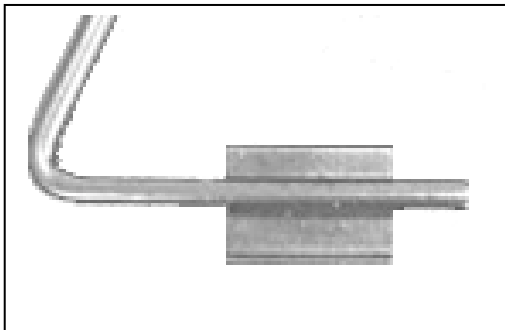

#370 Seismic Hook Tab attached to veneer tie.

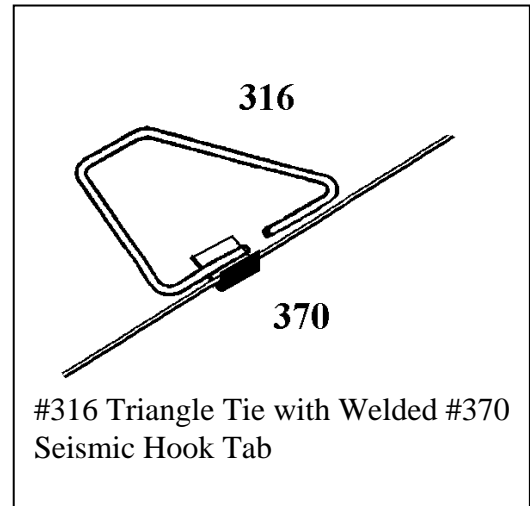

#316 Triangle Tie with Welded #370 Seismic Hook Tab

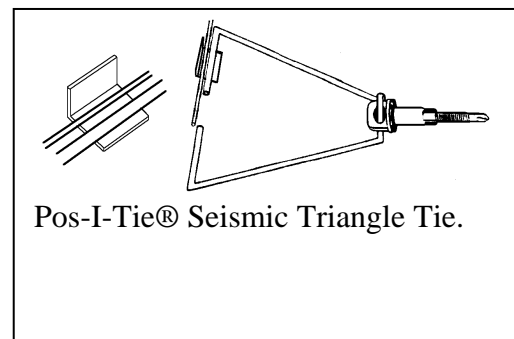

Pos-I-Tie® Seismic Triangle Tie.

Stainless Steel:

Sheet metal anchors and ties: ASTM A 167 AISI Type 304.

Plate and bent bar anchors: ASTM A 666 AISI Type 304.

Wire ties and anchors: ASTM A 580 AISI Type 304.

Hotdip Galvanized:

ASTM A 153 Class B-2: (1.50 oz/ ft²)(0.46kg/m²)

Approvals:

Comments: